



PENINSULA
PACKAGING COMPANY
www.penpack.net



Grape Clamshells



Features:

- Meets the Sustainability Packaging Requirements of Major Retailers (eg Costco, Sam's, Wal*Mart)
- Side Slot, Top and Bottom Hole Vents
- Secure "Dog Bone" Pin-Locks
- Self Aligning Locking Pins
- Secondary Lid-to-Base "Bridge" Supports on Many
- Denesting Lugs for Easy Separation
- 5-Down Footprint
- International Resin Codes
- Made with up to 100% Tough Recycled PET Drink Bottles
- Made with 50% Clean Solar Non-Polluting Renewable Energy from the Sun
- Made in USA

2-Pound Grape
(H7550)

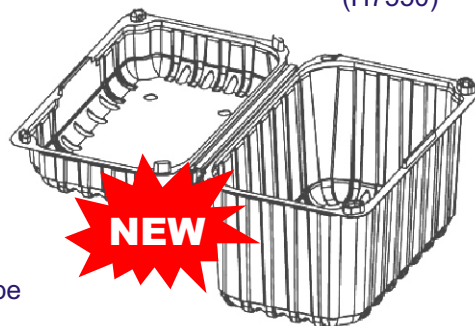

4-Pound Grape
(H9571-2)

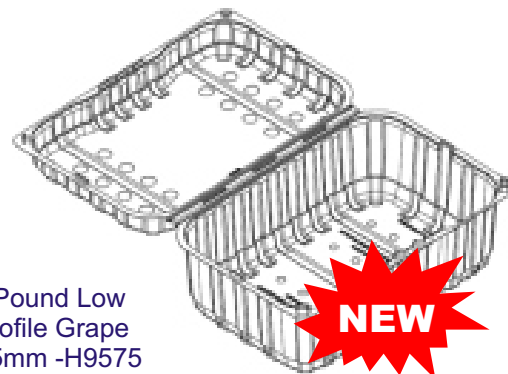
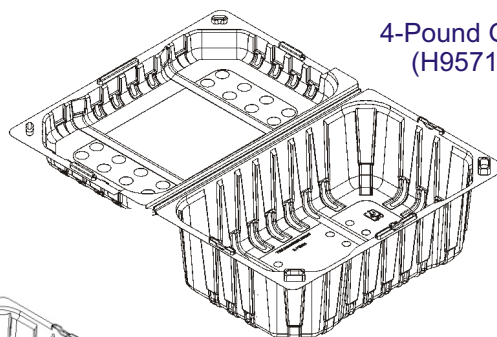

4-Pound Low
Profile Grape
(115mm -H9575
110mm - H9474)

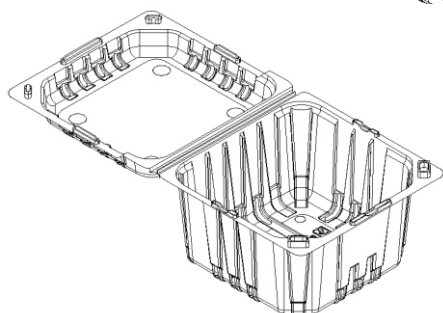

3-Pound Grape
(H7580)

See Other Side for Specifications

Facility Locations:

Corp Offices







1030 N. Anderson Rd.
Exeter, CA 93221
(559) 594-6813
sales@penpack.net

2540 Wilco Blvd.
Wilson, NC 27894
(252) 265-5590
ncsales@penpack.net



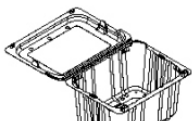

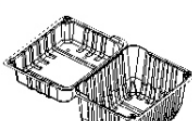
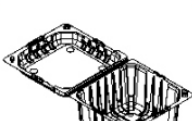
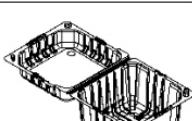
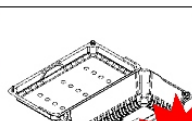

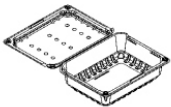

Many produce items are available labeled with top and bottom labels.
All produce items are made from PET plastic and contain up to 70% post-consumer recycled drink bottles.
Up to 50% self-generated clean energy from the SUN is used in the manufacturing of Peninsula's packaging products.
Contact your Peninsula sales representative for details.

GRAPE PACKAGING

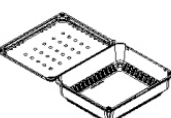
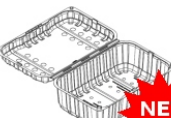
Description	Product Picture	Item Number(s)	Outside Dimensions - Inches (mm)				Inside Dimensions - Inches (mm)				Closure	Case Count	Cases per Pallet
			Length	Width	Height	Closed Height	Length	Width	Height	Closed Height			
1 lb. Cherry PAT NO D569243		H7256	7-1/8 (181)	5-5/8 (143)		2-11/16 (68)	6-5/8 (168)	5-1/8 (130)		2-11/16 (68)	Pins Patent Pending	260	24
2 lb. Squat Cherry PAT NO D569243		H7260	11 (279)	7-1/4 (184)		2-1/4 (57)	10-1/2 (267)	6-3/4 (171)		2-1/4 (57)	Pins Patent Pending	150	24
18 oz Blueberry Clamshell with Raised Insert in Tub	 NEW	H7346	7-1/4 (184)	4-3/4 (211)		2-7/8 (73)	6-5/8 (168)	4-3/16 (106)		2-1/2 (64)	Perimeter	TBD	TBD
2 lb. Cherry PAT NO D569243		H7455	7-1/8 (181)	5-5/8 (143)		4-1/16 (103)	6-5/8 (168)	5-1/8 (130)		4-1/16 (103)	Pins Patent Pending	180	24
10/2 lb Grape Clamshell	 NEW	H7550	7-3/8 (187)	4-3/4 (121)		5 (127)	7 (178)	4-3/16 (106)		4-7/8 (124)	Pins Patent Pending	420	24
2 lb. Grape (Produce) Hinged-Lid Approx Vol 129.5 cu in		H7561-1	7-1/8 (181)	5-5/8 (143)		5 (127)	6-1/2 (165)	4-7/8 (124)		4-7/8 (124)	Tri-Lock Button	300	24
3 lb Grape Approx Vol 185.6 cu in		H7580	7-1/8 (181)	7-3/8 (187)		5 (127)	6-3/4 (171)	7 (178)		4-7/8 (124)	Pins Patent Pending	240	24
4 lb. Plum		H7680	7-1/8 (181)	7-3/8 (187)		5-1/2 (140)	6-3/4 (171)	7 (178)		5-3/8 (136)	Pins Patent Pending	240	24
2 lb 8 Down (compatible with 8-down shipping cartons)	 NEW	H9361	9-7/16 (240)	5-1/2 (140)		3-1/2 (89)	9-1/8 (232)	5 (127)		3-7/16 (87)	Pins Patent Pending	200	24
2 lb. Modular Produce Hinged-Lid - Regular		H9370	11 (279)	7-1/4 (184)		3-1/8 (79)	9-3/4 (248)	6 (152)		3-1/8 (79)	Pins Patent Pending	136	24

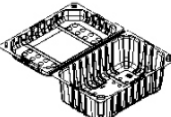
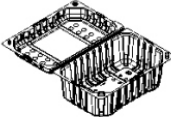
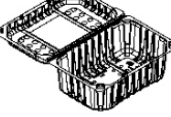
GRAPE PACKAGING

Description	Product Picture	Item Number(s)	Outside Dimensions - Inches (mm)				Inside Dimensions - Inches (mm)				Closure	Case Count	Cases per Pallet
			Length	Width	Height	Closed Height	Length	Width	Height	Closed Height			
2 lb. Standard Produce Hinged-Lid SHALLOW		H9378	9-3/8 (238)	7-3/8 (187)		2-7/8 (73)	8-1/2 (216)	6-3/8 (162)		3 (76)	Tri-Lock Button	120	36
3 lb. Cherry PAT NO D569243		H9381	11 (279)	7-1/4 (184)		2-13/16 (71)	10-1/2 (267)	6-3/4 (171)		2-13/16 (71)	Pins Patent Pending	170	24
4 lb - 8-Down Berry Clamshell		H9399	11 (279)	9-1/4 (235)		3-1/8 (79)	10-3/4 (273)	9 (229)		2-1/2 (64)	Pins Patent Pending	130	24
4 lb Low Profile Grape Clamshell Approx Vol 295.3 cu in (110 mm)	 NEW	H9474	11-3/8 (289)	7-1/2 (190)		4-3/8 (110)	10-7/8 (276)	7 (178)		4-3/16 (106)	Pins Patent Pending	150	24
4 lb. Cherry PAT NO D569243		H9480	11 (279)	7-1/4 (184)		3-11/16 (94)	10-1/2 (267)	6-3/4 (171)		3-11/16 (94)	Pins Patent Pending	110	24
4 lb. Standard Produce Hinged-Lid		H9492	11-1/4 (286)	8-3/4 (222)		3-5/8 (92)	10-1/4 (260)	8-1/16 (205)		3-1/2 (89)	Tri-Lock Button	68	32
4 lb. Produce (Grape) Hinged-Lid Approx Vol 275.3 cu in		H9571-2	11 (279)	7-1/4 (184)		4-3/4 (121)	10-1/8 (257)	6-1/2 (165)		4-5/8 (117)	Pins Patent Pending	150	24
5 lb. Produce (Grape) Hinged-Lid Approx Vol 308.8 cu in		H9572	11 (279)	7-1/4 (184)		5 (127)	10-1/8 (257)	6-1/2 (165)		4-7/8 (124)	Pins Patent Pending	150	24
4 lb. HEAVY DUTY LOCK Grape Approx Vol 275.3 cu in		H9573	11 (279)	7-1/4 (184)		4-3/4 (121)	10-1/8 (257)	6-1/2 (165)		4-5/8 (117)	Pins Patent Pending	150	24
4 lb Low Profile Grape Clamshell Approx Vol 313.8 cu in	 NEW	H9575	11-3/8 (289)	7-1/2 (190)		4-1/2 (115)	10-7/8 (276)	7 (178)		4-3/8 (111)	Pins Patent Pending	150	24



Many produce items are available labeled with top and bottom labels. Contact your Peninsula sales representative for details.
 All produce items are made from PET plastic and contain up to 100 percent post-consumer recycled materials.
 Clean energy from the SUN is used in the manufacturing of Peninsula's packaging products.
 Dimensions are to be used as guidelines only. Application should be verified from product samples.
 Subject to change without notice.