



PENINSULA

PACKAGING COMPANY

1030 N. Anderson Rd.
Exeter, CA 93221
Office (559) 594-6813
Fax (559) 594-6914
www.penpack.net



Utility Containers



Features:

- Perimeter Lock/Seal
- "Passive" Vents Allow Breathing without Dehydration
- Base Geometries Aid in Extended Shelf Life
- Denesting Lugs for Easy Separation
- 5-Down Footprint
- International Resin Codes
- Made with up to 100% Tough Recycled PET Drink Bottles
- Made with 50% Clean Solar Non-Polluting Renewable Energy from the Sun
- Made in USA
- Patents Pending

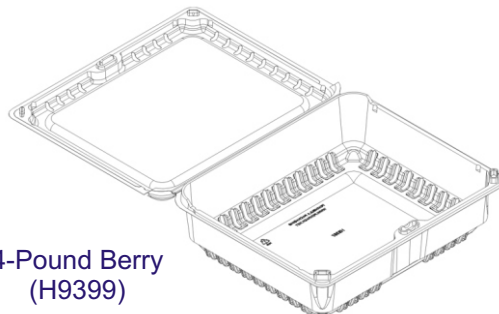

4-Pound Berry
(H9399)

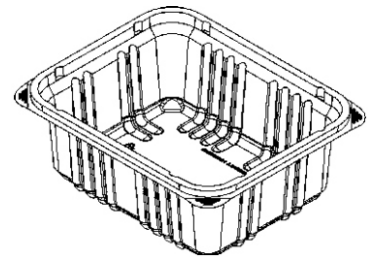

5 oz. Salad
(B8373-1)

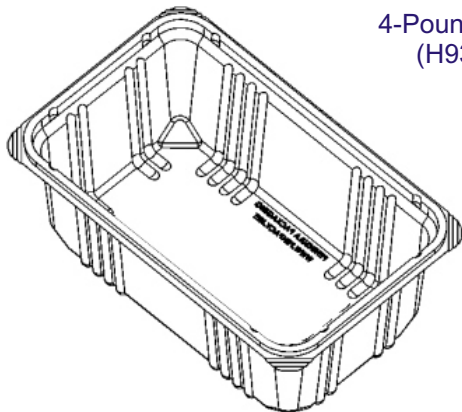

Utility Container -
Large - Flat Bottom
(B9579-1)

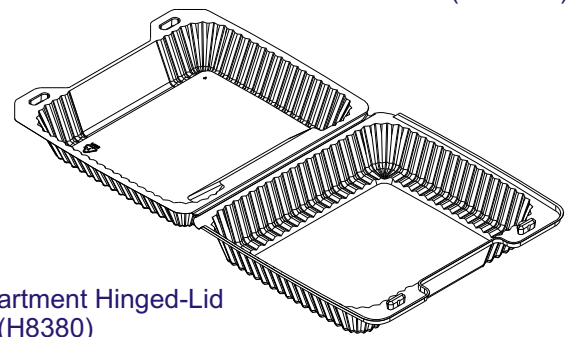

One-Compartment Hinged-Lid
(H8380)

See Other Side for Specifications









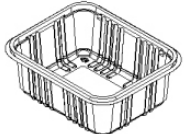

Many produce items are available labeled with top and bottom labels.
All produce items are made from PET plastic and contain up to 100% post-consumer recycled drink bottles.
Up to 50% self-generated clean energy from the SUN is used in the manufacturing of Peninsula's packaging products.
Contact your Peninsula sales representative for details.

Facility Locations:

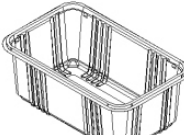

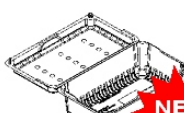

Corp Offices
1030 N. Anderson Rd.
Exeter, CA 93221
(559) 594-6813
sales@penpack.net

2540 Wilco Blvd.
Wilson, NC 27894
(252) 265-5590
ncsales@penpack.net

UTILITY CONTAINERS

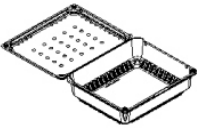
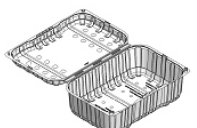
Description	Product Picture	Item Number(s)	Outside Dimensions - Inches (mm)				Inside Dimensions - Inches (mm)				Closure	Case Count	Cases per Pallet
			Length	Width	Height	Closed Height	Length	Width	Height	Closed Height			
10 Inch Bowl - Black		B9297-9	9-3/4 (248)	9-3/4 (248)	1-7/8 (48)		9-1/4 (235)	9-1/4 (235)	1-5/8 (41)		Perimter	110	32
5 oz Salad Tub		B8373-1	8-7/8 (225)	7-5/16 (186)	3-1/4 (83)		7-3/4 (199)	6-3/8 (192)	3 (76)		Perimter	220	36
11 oz Salad Tub		B9379-1	12-9/16 (319)	7-5/16 (202)	3-1/2 (89)		11-5/8 (295)	6-15/16 (176)	3-1/4 (83)		Perimter	260	18
16 oz Salad Tub		B9579-1	12-9/16 (319)	7-5/16 (202)	4-13/16 (122)		11-5/8 (295)	6-15/16 (176)	4-9/16 (116)		Perimter	2,340	1
Specialty Produce Clamshell		H7252	7-1/4 (184)	4-3/4 (121)		1-7/8 (48)	6-5/8 (168)	4-3/16 (106)		1-7/8 (48)	Perimter	420	24
1 lb. Cherry PAT NO D569243		H7256	7-1/8 (181)	5-5/8 (143)		2-11/16 (68)	6-5/8 (168)	5-1/8 (130)		2-11/16 (68)	Pins Patent Pending	260	24
2 lb. Squat Cherry PAT NO D569243		H7260	11 (279)	7-1/4 (184)		2-1/4 (57)	10-1/2 (267)	6-3/4 (171)		2-1/4 (57)	Pins Patent Pending	150	24
2 lb. Cherry PAT NO D569243		H7455	7-1/8 (181)	5-5/8 (143)		4-1/16 (103)	6-5/8 (168)	5-1/8 (130)		4-1/16 (103)	Pins Patent Pending	180	24
One Compartment Utility Clamshell with Shingle Fluted Side Wall Design		H8380	7-7/8 (200)	8-3/8 (213)		2-5/8 (67)	6-5/8 (168)	7-7/8 (200)		2-9/16 (65)	Pins Patent Pending	160	24
2 lb 8 Down (compatible with 8-down shipping cartons)		H9361	9-7/16 (240)	5-1/2 (140)		3-1/2 (89)	9-1/8 (232)	5 (127)		3-7/16 (87)	Pins Patent Pending	200	24

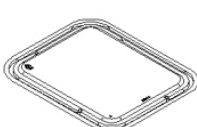
UTILITY CONTAINERS

Description	Product Picture	Item Number(s)	Outside Dimensions - Inches (mm)				Inside Dimensions - Inches (mm)				Closure	Case Count	Cases per Pallet
			Length	Width	Height	Closed Height	Length	Width	Height	Closed Height			
3 lb. Cherry PAT NO D569243		H9381	11 (279)	7-1/4 (184)		2-13/16 (71)	10-1/2 (267)	6-3/4 (171)		2-13/16 (71)	Pins Patent Pending	170	24
4 lb - 8-Down Berry Clamshell		H9399	11 (279)	9-1/4 (235)		3-1/8 (79)	10-3/4 (273)	9 (229)		2-1/2 (64)	Pins Patent Pending	130	24
4 lb Low Profile Grape Clamshell Approx Vol 295.3 cu in (110 mm)		H9474	11-3/8 (289)	7-1/2 (190)		4-3/8 (110)	10-7/8 (276)	7 (178)		4-3/16 (106)	Pins Patent Pending	150	24
8-Count Donut Peach Clamshell		H9475	11 (279)	7-1/4 (184)		3 (76)	9-3/4 (248)	6 (152)		3-7/16 (87)	Pins Patent Pending	170	24
4 lb. Cherry PAT NO D569243		H9480	11 (279)	7-1/4 (184)		3-11/16 (94)	10-1/2 (267)	6-3/4 (171)		3-11/16 (94)	Pins Patent Pending	110	24
5 oz Salad Tub Lid		L8374	8-7/8 (225)	7-5/16 (186)	5/16 (8)					5/16 (8)	Perimter	384	36
10 Inch Bowl Dome		L9197	9-3/4 (248)	9-3/4 (248)	1 (25)		9-1/4 (235)	9-1/4 (235)		3/4 (19)	Perimter	220	32
11-16 oz Salad Tub Lid		L9380	12-9/16 (319)	7-15/16 (202)	5/16 (8)					5/16 (8)	Perimter	500	18



Many produce items are available labeled with top and bottom labels. Contact your Peninsula sales representative for details. All produce items are made from PET plastic and contain up to 100 percent post-consumer recycled materials. Clean energy from the SUN is used in the manufacturing of Peninsula's packaging products. Dimensions are to be used as guidelines only. Application should be verified from product samples. Products listed as "X Series" are offered in multiple configurations (eg lid and base inserts). Subject to change without notice.