



PENINSULA  
PACKAGING COMPANY  
[www.penpack.net](http://www.penpack.net)



# Tomato Clamshells



## Features:

- Meets Sustainability Packaging Requirements of Major Retailers (eg Costco, Sam's, Wa\*Mart)
- Side Slot, Top and Bottom Hole Vents
- Perimeter Locks for Secure Machine or Hand Closure. Pin-Locks for Hand Closure
- Denesting Lugs for Easy Separation
- Made with up to 100% Tough Recycled PET Drink Bottles
- Made with 50% Clean Solar Non-Polluting Energy from the Sun
- 5-Down Footprints Available
- International Resin Codes
- Made in USA

2-3-Pound Roma  
H9380

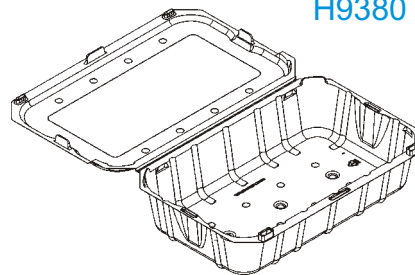

Pint  
H5344

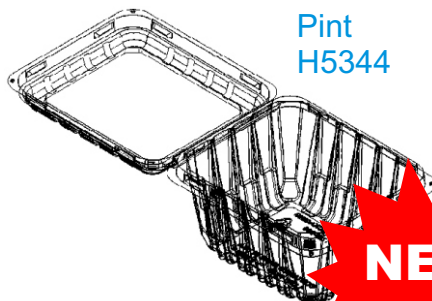

Pint  
H5350

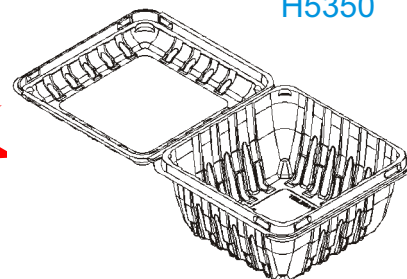

**NEW**

2-Pound  
H7380

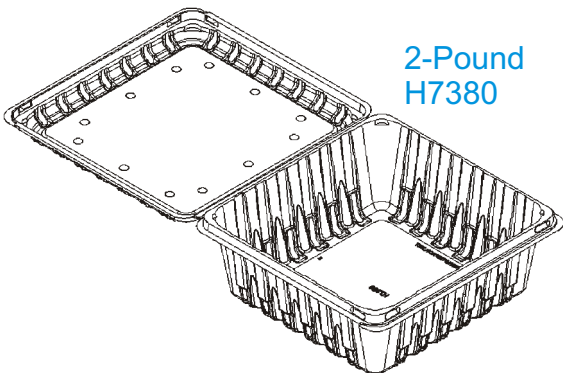

**See Other Side for Specifications**

## Facility Locations:

### Corp Offices





1030 N. Anderson Rd.  
Exeter, CA 93221  
(559) 594-6813  
[sales@penpack.net](mailto:sales@penpack.net)

2540 Wilco Blvd.  
Wilson, NC 27894  
(252) 265-5590  
[ncsales@penpack.net](mailto:ncsales@penpack.net)





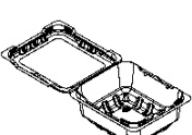
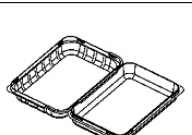
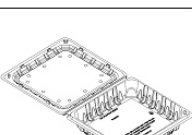
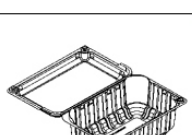
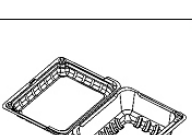
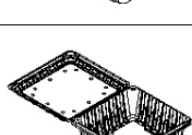

Many produce items are available labeled with top and bottom labels.  
All produce items are made from PET plastic and contain up to 100% post-consumer recycled drink bottles.  
Up to 50% self-generated clean energy from the SUN is used in the manufacturing of Peninsula's packaging products.  
Contact your Peninsula sales representative for details.

# TOMATO CLAMSHELLS

Description	Product Picture	Item Number(s)	Outside Dimensions - Inches (mm)				Inside Dimensions - Inches (mm)				Closure	Case Count	Cases per Pallet
			Length	Width	Height	Closed Height	Length	Width	Height	Closed Height			
5" x 5" Half Pint	 <b>NEW</b>	H5251	4-15/16 (125)	4-15/16 (125)		4-3/4 (121)	4-3/4 (121)	1-11/16 (43)	1-11/16 (43)	Perimter	444	36	
5344 Dry Pint	 <b>NEW</b>	H5344	5 (127)	4-3/8 (111)		3-1/16 (78)	4-1/2 (114)	3-7/8 (98)	2-3/8 (60)	Perimter	504	24	
5 x 5 Pint		H5350	4-15/16 (125)	4-15/16 (125)		4-3/4 (121)	4-3/4 (121)	2-11/16 (68)	2-9/16 (65)	Perimter	444	30	
1/2 Pint Modular Hinged-Lid - Vented		H6150	5-1/2 (140)	4-1/16 (103)		1-9/16 (40)	4-7/8 (124)	4-5/16 (109)	1-7/16 (36)	Perimter	420	30	
Pint Modular Hinged-Lid (8 oz Modular)		H6250	5-1/2 (140)	4-1/16 (103)		2-1/2 (64)	4-7/8 (124)	4-5/16 (109)	2-5/16 (59)	Perimter	390	30	
Specialty Produce Clamshell		H7252	7-1/4 (184)	4-3/4 (121)		1-7/8 (48)	6-5/8 (168)	4-3/16 (106)	1-7/8 (48)	Perimter	420	24	
18 oz Blueberry Clamshell		H7270	7-1/8 (181)	7-7/16 (189)		6-1/2 (165)	6-3/4 (171)	1-1/2 (38)	1-1/2 (38)	Pins Patent Pending	360	24	
1 lb. Standard Produce Hinged-Lid		H7358	7-1/4 (191)	4-3/4 (121)		3-1/2 (89)	6-5/8 (168)	4-3/16 (106)	3-3/8 (86)	Pins Patent Pending	480	36	
1 lb Modular Produce Hinged-Lid		H7364	7-1/8 (181)	5-5/8 (143)		3-1/8 (79)	6-5/16 (161)	4-5/8 (117)	3 (76)	Tri-Lock Button	440	30	
2 lb Grape Tomato		H7380	7-1/8 (181)	7-7/16 (179)		3 (76)	6-3/4 (171)	6-1/2 (165)	2-7/8 (73)	Perimter	252	24	

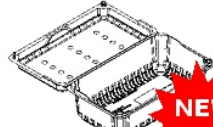
# TOMATO CLAMSHELLS

Description	Product Picture	Item Number(s)	Outside Dimensions - Inches (mm)				Inside Dimensions - Inches (mm)				Closure	Case Count	Cases per Pallet
			Length	Width	Height	Closed Height	Length	Width	Height	Closed Height			
12 oz. Raspberry Clamshell		H9251	9-3/4 (248)	4-13/16 (122)		1-1/2 (38)	9-1/8 (232)	4-1/4 (108)		1-1/2 (38)	Pins Patent Pending	560	16
1 lb 8 Down Squat Clamshell	 <b>NEW</b>	H9255	9-7/16 (240)	5-1/2 (140)		1-5/8 (41)	9-1/8 (232)	5 (127)		1-5/8 (41)	Pins Patent Pending	340	24
2 lb 8 Down (compatible with 8-down shipping cartons)	 <b>NEW</b>	H9361	9-7/16 (240)	5-1/2 (140)		3-1/2 (89)	9-1/8 (232)	5 (127)		3-7/16 (87)	Pins Patent Pending	200	24
2 lb. Modular Produce Hinged-Lid - Regular		H9370	11 (279)	7-1/4 (184)		3-1/8 (79)	9-3/4 (248)	6 (152)		3-1/8 (79)	Pins Patent Pending	136	24



Many produce items are available labeled with top and bottom labels. Contact your Peninsula sales representative for details.  
 All produce items are made from PET plastic and contain up to 100 percent post-consumer recycled materials.  
 Clean energy from the SUN is used in the manufacturing of Peninsula's packaging products.  
 Dimensions are to be used as guidelines only. Application should be verified from product samples.  
 Products listed as "X Series" are offered in multiple configurations (eg lid and base inserts).  
 Subject to change without notice.